



**KMF 083 03**

**NEW**

**Allied Motion**



## **KinetiMax HPD Brushless DC Outer-Rotor Motors High Power Density, Frameless Stator-Rotor Sets**

*62 to 125 mm diameter, 0.16 to 6.30 Nm continuous torque, up to 1100 Watts output*

Motion Solutions  
that Change the Game



## KinetiMax HPD Brushless DC Outer-Rotor Motors High Power Density, Frameless Stator-Rotor Sets

*62 to 125 mm diameter, 0.16 to 6.30 Nm continuous torque, up to 1188 Watts output*

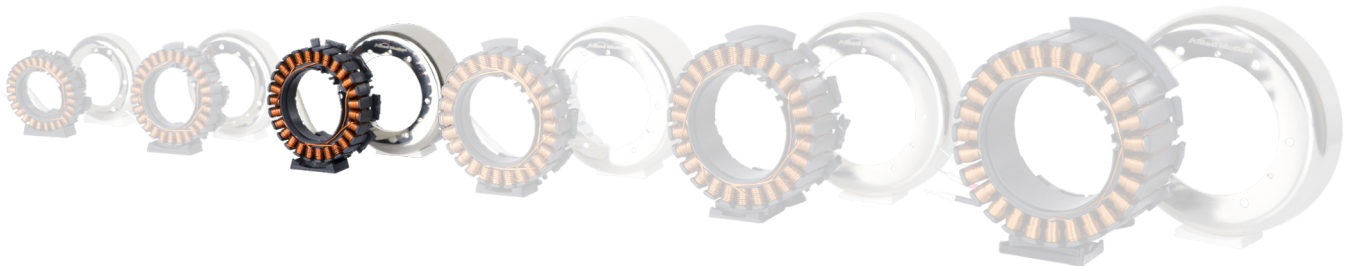

The KinetiMax HPD range of outer-rotor brushless DC motors comes in frameless stator-rotor part sets. Available in six frame sizes and three stack-heights each, the HPD series enables you to select an optimum configuration with an exact performance fit for your application.

These compact kit motors offer an ideal solution especially where total motor length is crucial in space-constrained applications.

Their large stator ID (Inner Diameter) makes integration of larger ball-bearings possible, and the large clear aperture ID permits cabling to pass through the motor.

The HPD's excellent high torque-to-weight ratio is essential in applications where weight is critical. And with an efficiency ranging from 81% to 91% in a wide speed-torque range, the KinetiMax HPD frameless motors are ideal for battery-fed applications, where they help maximize the running time per battery charge.

Their low cogging torque combined with high peak torque improves motor behavior in servo applications.

### Features & Benefits

- Winding selection for other Voltages
- Rated torque 0.16 to 6.30 Nm
- High torque-to-weight ratio
- Excellent efficiency from 81% up to 91% over a wide range around the nominal working point

### Options & Accessories

- Hall commutation sensor board
- Temperature sensor mounted on stator

### Typical Applications

- Automated Guided Vehicles (AGV)
- Robotics (arms, joints)
- Handheld hydraulic power tools
- Material handling systems
- Medical equipment
- Rotary actuators
- Gimbals



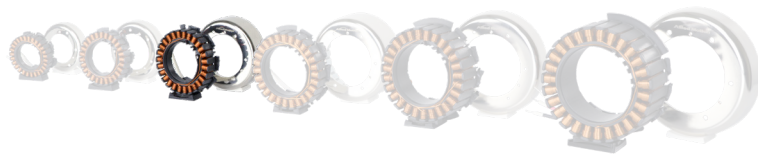

## Specifications

Winding Identification <sup>3</sup>		C	D	E	F	G	H	J	K
Nominal Supply Voltage DC Link	Volt	30	42	54	72	72	72	72	72
Rated Output Power <sup>1</sup>	Watt	411	463	429	459	327	240	182	132
Rated Speed	rpm	2410	2714	2510	2686	1914	1408	1065	770
Rated Torque <sup>1</sup>	Nm	1.63							
Rated Line Current <sup>1,4</sup>	Arms	11.7	9.4	6.8	5.4	3.9	2.9	2.3	1.7
Max. Efficiency	%	88							
No Load Speed RPM (@ nominal voltage)	rpm	2517	2819	2616	2790	2013	1510	1162	872
BEMF Constant <b>Ke</b>	V/krpm	11.9	14.9	20.6	25.8	35.8	47.7	61.9	82.6
Motor Speed Constant <b>Kv</b> (=1/Ke)	rpm/V	83.9	67.1	48.4	38.7	28.0	21.0	16.1	12.1
Continuous Stall Torque <sup>1</sup>	Nm	2.00							
Continuous Stall Line Current (rms) <sup>1</sup>	Arms	14.3	11.5	8.3	6.6	4.8	3.6	2.8	2.1
Peak Torque	Nm	6.00							
Max. Demagnetization Line Current	A	101	81	59	47	34	25	20	15
Torque/rms Line Current <b>Kt</b> <sup>4</sup>	Nm/Arms	0.139	0.174	0.241	0.302	0.418	0.558	0.724	0.966
Resistance (terminal-to-terminal)	mOhm	89	136	262	405	745	1363	2201	4053
Inductance (terminal-to-terminal)	μH	86	134	257	401	770	1369	2310	4107
Back EMF (@3000 RPM terminal-to-terminal)	Vrms	8.4	10.5	14.6	18.2	25.3	33.7	43.8	58.4
Thermal Resistance (stator/rotor to ambient) <sup>1</sup>	°C/W	1.91							
Thermal Resistance Winding-Housing	°C/W	0.70							
Max. Winding Temperature	°C	160							
Number of Pole Pairs		15							
Weight	kg	0.69							
Rotor Inertia - Large I.D.	kgm <sup>2</sup> * E-6	377							
Rotor Inertia - Small I.D.	kgm <sup>2</sup> * E-6	388							
Mechanical Time Constant	ms	1.7							
Electrical Time Constant	ms	1.0							
Motor Constant <b>Km</b>	Nm/sqrt(W)	0.389							
Cogging Torque (typical, peak to peak)	Nm	0.041							
Drag Torque	Nm	0.033							
Viscous Damping	Nm/rpm	2.6E-05							
Thermal Time Constant of Winding only	s	16							
Adiabatic Heating of Winding at Peak Torque	K/s	6							
Rotor Inner Diameter [V] <sup>2</sup>	mm	51							
Rotor Inner Diameter [W] <sup>2</sup>	mm	20							
Rotor Outer Diameter [Z] <sup>2</sup>	mm	83.9							
Stator Inner Diameter [Y] <sup>2</sup>	mm	45.5							
Total Height [X] <sup>2</sup>	mm	42.5							
Motor lead wire AWG size		12	12	14	14	20	20	20	20

(1) Assuming the stator-rotor set is mounted on a bracket with an aluminium flange diameter 1.5 times rotor diameter.

(2) See the dimensions in the drawing on the next page.

(3) Windings C, D, G and H are delta connected, windings E, F, J and K are wye connected.

(4) Line currents are the AC currents running into the three terminals of the stator.

## T-n and T-I curves

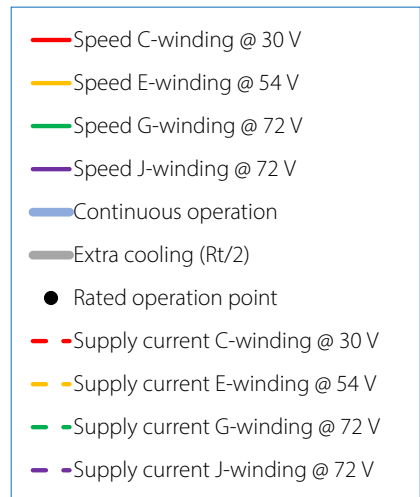
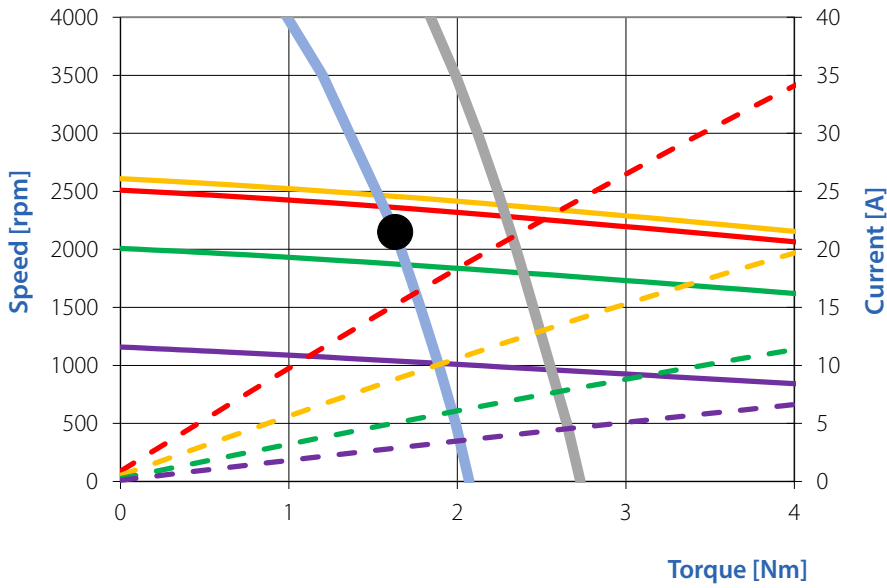

Supply current is the DC current taken from the DC power supply by the drive. The torque-speed curves and torque-current curves are made assuming a FOC drive is used.

## T-Efficiency

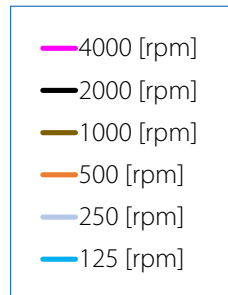
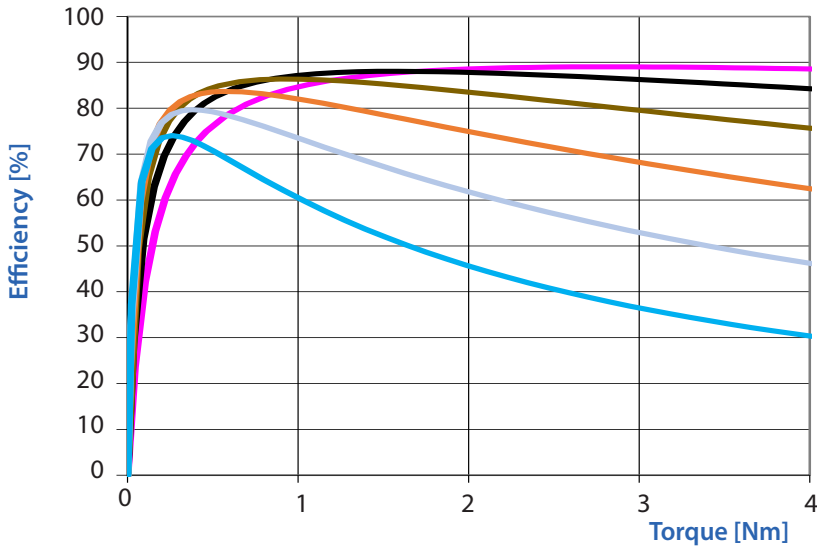

## Outline Dimensions

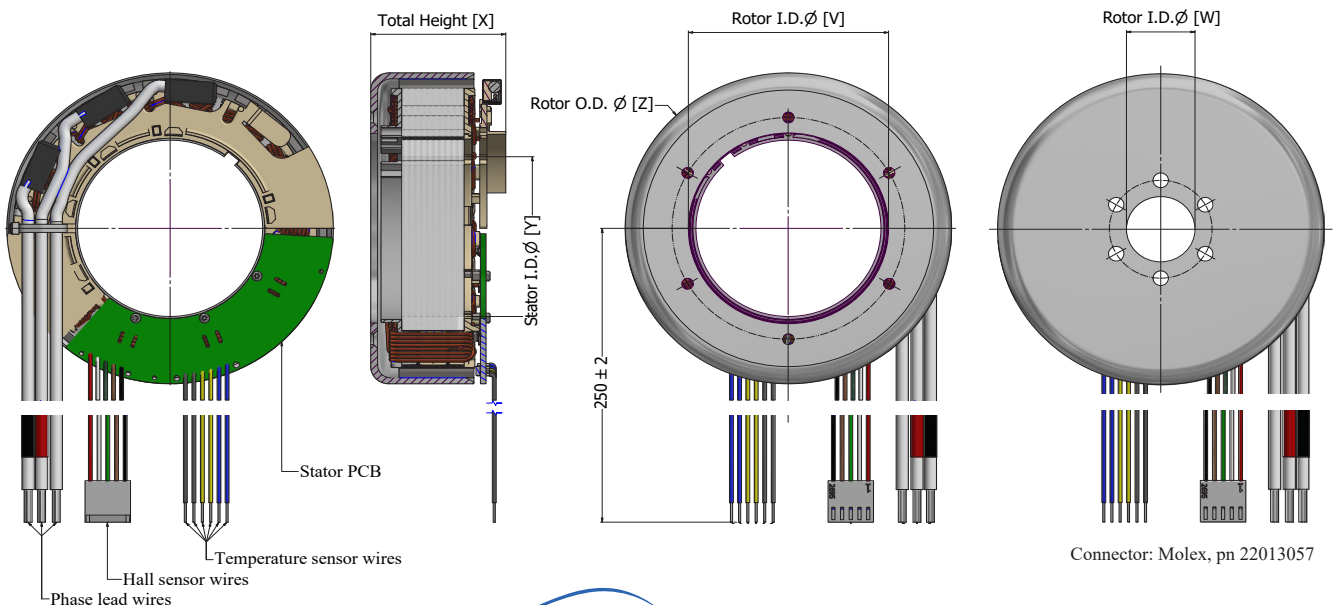

# Sensors

## Hall sensors

### Hall sensor connections / specifications:

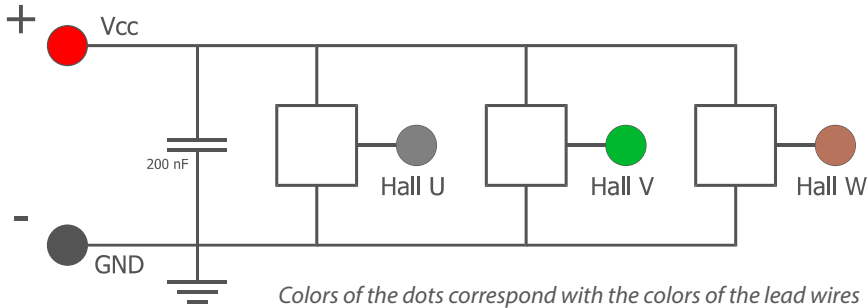

Specification Item	Value [Typ.]
Supply Voltage [VCC]	3.0 - 32 V
Supply Current	4.8 mA
Temperature Range	-40 °C + 170 °C
Output Type	Open drain
Max Output Voltage	32 V
Max Output Current	25 mA

### Hall sensors switching sequence:

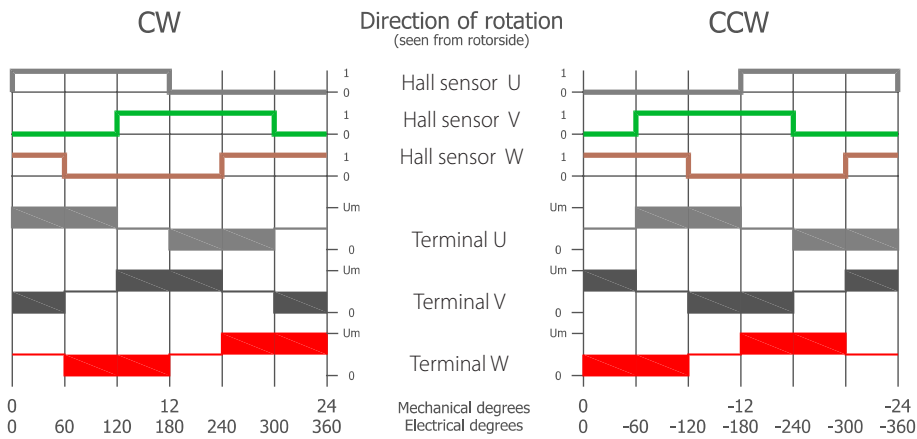

The colors of the 3 Hall sensor signals correspond with the 3 colors of the Hall lead wires.  
The colors of the 3 signals of the terminals U, V, W, correspond with the 3 colors of the motor lead wires.

## Temperature sensors

### Temperature sensor connections / specifications:

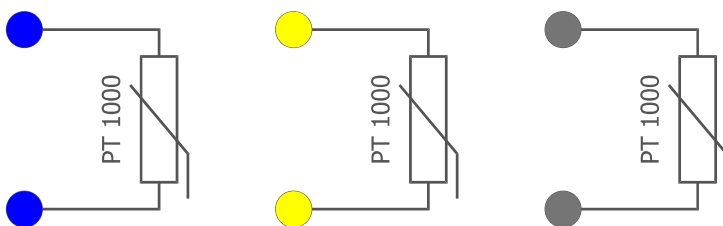

Specification Item	
Resistance at 0 °C	1000 Ohm
Temperature coefficient	+ 3850 ppm/K
Temperature Range	-40 °C to +175 °C
$\Delta T^{(1)}$	T.B.D.

Colors of the dots correspond with the colors of the lead wires, each wire color is used for a different motor phase.

(1) Due to the thermal coupling between the winding and sensor, the temperature measured by the sensor will be lower than the actual temperature of the winding.

Optional sensor types are possible after consulting the factory (PTC, NTC).



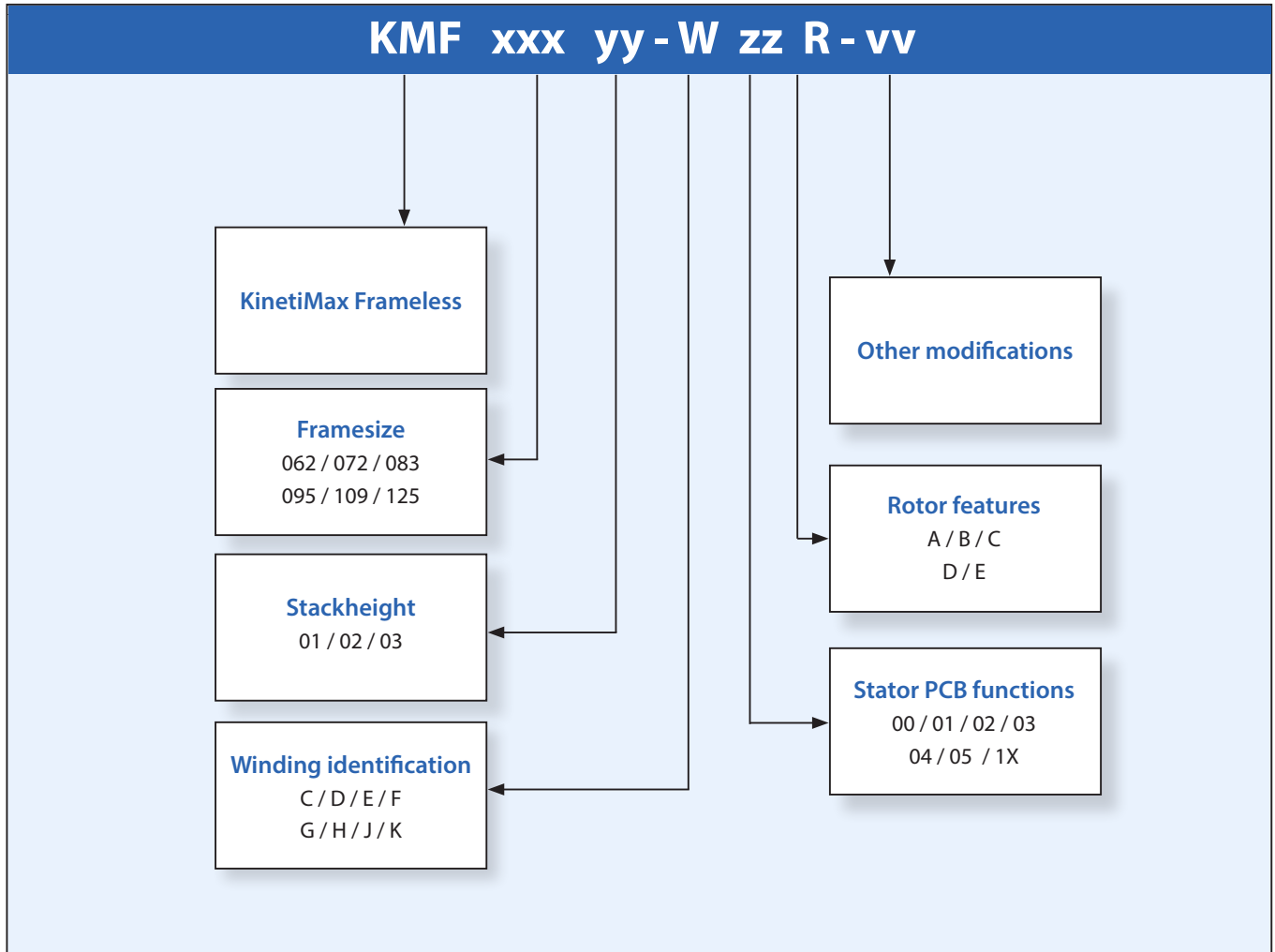

ZZ	Stator PCB functions
00	No PCB
01	PCB with 3 Hall sensors
02	PCB with 1 Temperature sensor only
03	PCB with 3 Hall sensors and 1 Temperature sensor
04	PCB with 3 Temperature sensors only
05	PCB with 3 Hall sensors and 3 temperature sensors
1X	Starting with 1 are custom PCB's

R	Rotor features
A	Large bore hole, G40 balancing class
B	Small bore hole, G40 balancing class
C	Large bore hole, G16 balancing class
D	Small bore hole, G16 balancing class
E	Custom rotor or balancing

With **Other modifications** are meant custom added parts to stator or rotor like a stator bracket, other leadwires with connector or a rotor nave/shaft etc.

## Allied Motion Solution Centers

Allied Motion Solution Centers provide support to customers around the world from five geographically-strategic locations. Each facility is staffed by experienced application engineers and customer service teams to assist you with all aspects of your motion control needs. We also have a global network of factory-trained Allied Motion Sales Partners to serve you. For contact information on the location nearest you, please see below or visit our website.

### Global Presence and International Support



#### North America (US, Canada, Mexico)

**Amherst, New York (HQ)**  
+1 (716) 242-7535  
[inquiry@alliedmotion.com](mailto:inquiry@alliedmotion.com)

#### Europe

**Kelheim, Germany**  
+49 9441/707 - 0  
[inquiry.eu@alliedmotion.com](mailto:inquiry.eu@alliedmotion.com)

#### Asia

**Changzhou, Jiangsu, China**  
+86-(0)519-8511 3625  
[inquiry@alliedmotion.com](mailto:inquiry@alliedmotion.com)

**Dordrecht, Netherlands**  
+31 (78) 621 9940  
[inquiry.nl@alliedmotion.com](mailto:inquiry.nl@alliedmotion.com)

**Bromma, Sweden**  
+46 (8) 546 11 100  
[inquiry.eu@alliedmotion.com](mailto:inquiry.eu@alliedmotion.com)